



Sigma Simplicity

Operator & Installation Manual

Sigma Simplicity Operator contents

- 3 Safety
- 4 Preface, concepts and definitions
- 5 Liability & warranty - spare parts
- 6 Responsibility of the operating company
- 7 Inspection upon delivery
- 8 Introduction
- 9 Sigma Simplicity external layout at a glance
- 10 Sigma Simplicity description of the internal parts
- 11 Description of internal door at a glance
- 12 Cup unit
- 13 Cleaning external door & daily cleaning summary
- 14 Weekly cleaning summary & ingredient canisters
- 15 Whipper assembly & overflow bucket
- 16 How to dismantle the bean to cup & fresh brew coffee brewer for cleaning
- 17 Clean the nylon filter belts every 1250 vends & flush buttons
- 18 Dispense head & dispense pipe lengths
- 19 Sanitising the syrup lines
- 20 Door open software menus
- 21 Retrieve the audit via USB
- 22 Door open software menus

Published by:
Westomatic Vending Services Ltd
Units 7-8 , Block 4 , Forde Court, Forde Road
Newton Abbot
Devon TQ12 4BT
United Kingdom
www.westomatic.com

Sales: +44 (0) 1626 323100

Email sales@westomatic.com

Westomatic Vending Services Ltd. reserves the right to change the product specifications at any time. While every effort has been made to ensure that the information in this publication is accurate, Westomatic Vending Services Ltd disclaims any liability for any direct or indirect losses howsoever caused arising out of use or reliance on this information.

Information contained herein is correct at time of print: Revision 6 – September 2016 = ^{v6}

Safety

- This document is intended for use as a reference book for qualified Operators and Service engineers. It is recommended that any person undertaking installation and/or service activity on this machine has previously attended a formal Westomatic training course specific to this vending machine type.
- This appliance is not intended for use by persons (including children) with reduced physical, sensory or mental capabilities, or lack of experience and knowledge, unless they have been given supervision or instruction concerning use of the appliance by a person responsible for their safety.
- Children under 8 yrs old must be supervised to ensure they do not play with the machine.
- Installation and service activity, including replacement of the mains cable, on this vending machine should only be undertaken by a competent person who is fully conversant with the potential dangers of working on live electrical equipment and mains pressure water systems.
- Extension cables or longer mains leads **must not be used to power this vending machine.**
- The mains lead should be kept away from hot surfaces and sharp edges.
- Each new vending machine is supplied with a new mains water inlet hose. Do not reuse an existing or old water hose.
- Prior to any service activity, switch off and isolate the water and electrical supply. If in doubt refer to BS7671 for safe isolation procedures. Servicing of live equipment must **never** be undertaken.
- Use insulated tools and insulated probes on test equipment. HSE guidance notes 38 provides guidance on the selection of suitable test probes, leads, lamps, voltage indicating devices and other measurement equipment used by electricians when working on or investigating power circuits.
- There are no user serviceable parts inside this vending machine.
- The Sigma Simplicity machine must be cleaned on a regular basis (refer to the section within this document on how to clean your machine). A water jet **must not** be used.

Preface

This document is intended to be used as a reference book for qualified Installation Engineers and Operators to be able to install, commission, programme, maintain and to carry out basic fault finding diagnostics on the Sigma Simplicity vending machine.

Information on the operation, the use of and cleaning of the machine can be found in the operational and cleaning sections of this manual.

Concepts and definitions

Description	Definition
User	The person who uses the machine exclusively for vending a drink. The user will have NO access to the inside of the machines.
Service Technician and/or Installation Engineer	A competent professional who has been trained on the machine and is aware of the dangers involved. They must have a thorough knowledge of the electronics and mechanical parts of the machine and be qualified to install, commission, programme, maintain and repair the machines.
Operator	A qualified individual who is responsible for cleaning the machine, filling ingredients and cups, and has knowledge of removing brewers and the total whipper assembly for periodic cleaning.
Service Operator	A person who can carry out basic fault finding and the duties of an Operator, and therefore must be competent in both of these areas.
Westomatic	Westomatic Vending Services Ltd, the machine manufacturer.

Westomatic Vending Services Ltd offers training programmes for the Sigma Simplicity hot beverage vending machines. Please contact your account manager for more information.

Liability & warranty

General

All details and indications for the installation and cleaning of this vending machine have been made under consideration of our knowledge and experiences collected up to now.

Westomatic Vending Services Ltd. reserves the right to make technical changes to this machine type without notice as a result of continuous product development.

Text translations are made to the best of Westomatic's knowledge. However, we exclude any liability for translation errors. The English version of the operation instructions shall prevail for warranty purposes.

The presented texts and drawings do not necessarily correspond to the scope of delivery. The drawings and graphics are not to scale.

The instructions contained herein must be carefully read before machine installation or operation is started.

Westomatic Vending Services Ltd does not bear liability for any damage or disturbance resulting from non-observance of the instructions in this manual.

It is strictly forbidden to make this manual or the operator instructions accessible to any third party.

Non-observance will result in a claim for damages.

Spare parts

Only genuine, original Westomatic spare parts should be used when servicing this machine.

ATTENTION!

Faulty or defective non-Westomatic spare parts may lead to incorrect machine operation or damage. Where non-Westomatic spare parts are used, all obligations of Westomatic Vending Services Ltd. such as warranties, service contracts etc. are void without prior notice and agreement.

Part sales tel: +44 (0) 1626 323100

Responsibility of the operating company

In order to avoid faulty machine operation and ensure safe Operator/cleaning practices, this user manual and the associated operator guide should be stored inside the purpose built document holder located within the vending machine and be accessible to all persons involved in the machine installation, operation, maintenance and cleaning at any time.

This vending machine must only be operated within a safe and reliable environment.

The information in this document relating to machine operational safety is based upon the essential health & safety requirements in force within the European Union at the time of publication. During the operating life of the machine it is the responsibility of the operating company to assess any differences in any new legislation and update the operational safety instructions along with their own safe working practices accordingly. Outside the European Union, the regulations valid at the place of installation and the regional regulations therein must be observed.

Appropriate use

Westomatic Vending Services Ltd. will only undertake machine operational liability when the machine is used appropriately and in accordance with the operating instructions to perform assembly, operational, servicing / maintenance and cleaning activities.

NOTE:

Any machine usage outside of the above scope is forbidden and is defined as 'not appropriate'. In this situation, any entitlement to damages against Westomatic Vending Services Ltd. and / or representatives because of inappropriate use will be excluded. The operating company alone is liable for all damages arising from inappropriate use.

ATTENTION!

The operating company is obliged to install the necessary safety precautions to ensure the vending machine can be stopped immediately in the event of danger or disturbance.

Inspection upon delivery

Once your machine has been delivered, please immediately check for completeness and possible damage caused by transportation.

In case of externally recognisable transport damages, please do not accept delivery or only under reservation. Note the extent of any damage on the transport documents/delivery note of the forwarding agent. If required, please contact the Westomatic helpline as soon as possible to register any product damage as a customer complaint can only be asserted within the currently valid time limits.

Helpline Tel: +44 (0) 1626 323100

Introduction

The information held within this section has been compiled by the manufacturer to provide recommended guidelines to operator personnel and is intended to be used in conjunction with any existing operating procedures your company uses.

Hygiene

In accordance with the food hygiene (Amendment) regulations 1990 (SI 1990 No. 1431) and in compliance with the local public health authority requirements, it is the responsibility of the machine Operator to keep this machine maintained in a clean condition to ensure the highest standards of hygiene needed to prevent the formation of bacteria. A regular, systematic method of cleaning will help achieve this condition.

A high standard of personal hygiene is essential for a vending machine Operator. Clothing must be neat and clean and loose hair should be tied back accordingly. Hands and fingernails must be washed thoroughly before work commences, particularly after each visit to the toilet area. Jewellery should be kept to a minimum and preferably removed during any cleaning operations.

An operative who is suffering from cuts, sores or any form of illness must inform their immediate superior at once and must not come into contact with this vending machine, ingredient products, cups or any other machine related items. The operative must not resume work until authorised to do so by their immediate superior.

Important safeguards

1. Read these instructions before attempting to clean or refill the machine.
2. Do not attempt to operate the machine if any part is damaged. If either damage or a fault is suspected contact your nearest available Service Engineer for assistance.
3. Never immerse the machine in water or any other liquid.
4. Never clean the machine with a water jet.
5. Always switch off and disconnect the machine from the mains electricity supply before cleaning and servicing.

Sigma Simplicity external layout at a glance ^{V5}

1. Graphics
2. 12 inch digital screen
3. LCD screen
4. Touch sensitive keypad
5. Reject button & coin entry
6. Door lock
7. Cup sensor
8. Cup station
9. Cup rest
10. Cup shelf
11. Coin return

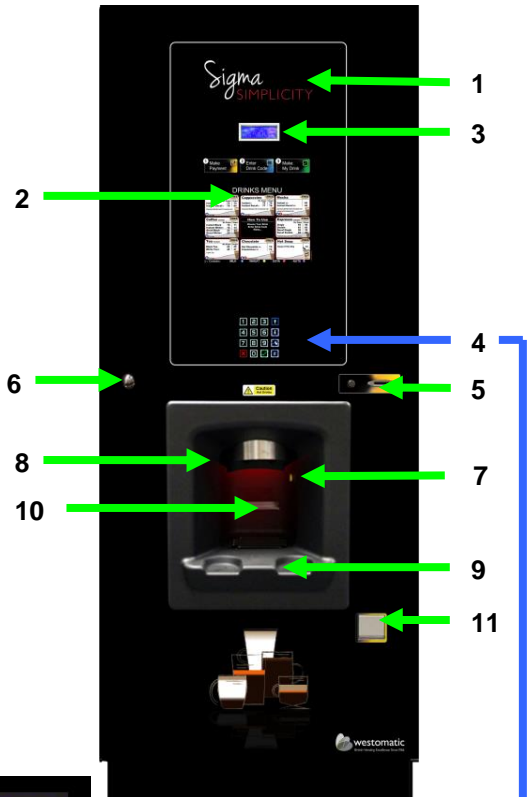

**Back out,
cancel &
save**

Enter

Up scroll button

Down scroll button

Sigma Simplicity description of the internal parts at a glance

1. Isolation switch
2. Canisters & lids
3. BTC hopper & lever
4. Canister chutes
5. Extraction plates
6. Whipper assembly
7. Whipper drip tray
8. Tea brewer
9. BTC brewer
10. Dispense pipes
11. Dispense strap
12. Dispense head
13. Moving dispense head
14. Syrup pumps
15. Overflow pipe
16. Waste bucket
17. Waste trip
18. Boiler drainage pipe
19. Overflow bucket

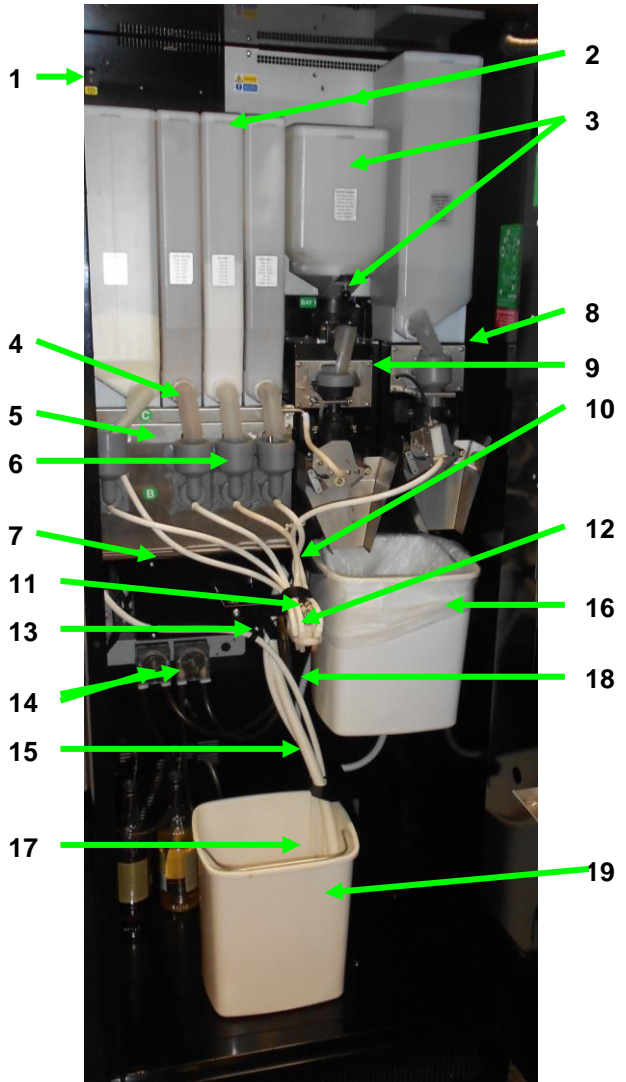

Description of internal door at a glance

1. Vend mode door switch
2. Flush buttons & USB port
3. Turret lid & claw
4. Carousel
5. Dispense instructions
6. Door lock bar
7. 12 inch menu screen
8. Cup unit assembly
9. Door lock assembly
10. Cup catcher
11. Cup sensor
12. Dispense head drip tray
13. Internal cup drip tray
14. Cash box

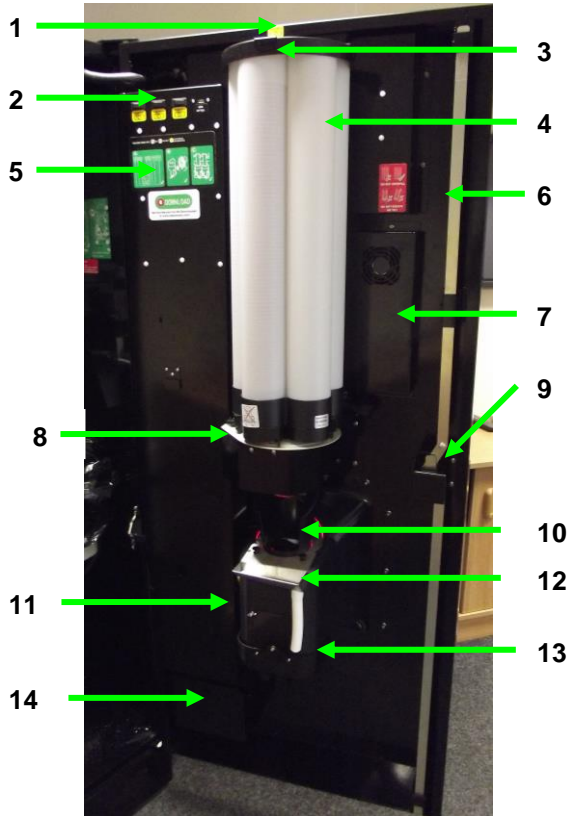

Cup unit

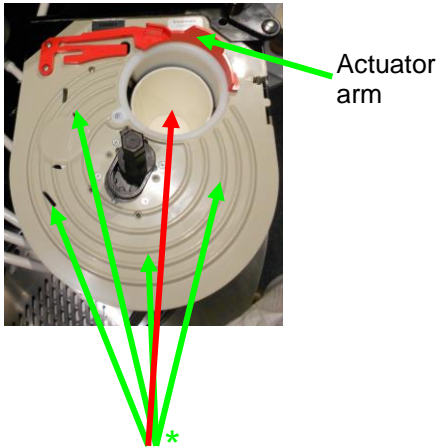

Loading cups

To correctly fill the carousel when empty:-

1. Ensure the machine is turned off.
2. Ensure the actuator arm is positioned on the outside of the cup carousel.
3. * With the door open load one sleeve of cups into the carousel tubes avoiding the dispense position highlighted with a red arrow.
4. Switch on the machine via the mains isolation switch. The carousel will then rotate until the cups drop into the dispense position cup ring.
5. Now fill the remaining columns.

IMPORTANT

DO NOT load cups into the dispense position.

DO NOT overfill the columns.

ALWAYS refit the carousel lid.

NEVER try to turn the carousel by hand as this will cause cup jams.

Cup units

There are 3 types of cup units, dependant on the size of cup is being used.

Cup Type	Cup Rim Diameter
7oz tall	70 mm
7oz squat / 9oz	73 mm
12oz	80 mm

© Copyright Westomatic Vending Services Limited 2016

All rights reserved. No part of this publication may be reproduced, stored in a retrieval system, or transmitted, in any form or by any means, electrical, mechanical, photocopying, recording or otherwise, without prior permission from Westomatic Vending Services Limited.

Cleaning external door

Tools required:

- Warm water
- Cloth
- Very soft microfibre cloth - for the Sigma Simplicity overlay.

Cleaning the Simplicity screen and front acrylic overlay

Do not use a cleaning agent on the front acrylic overlay.

- With the door open the touch sensitive keypad will still be active. Take care when cleaning^{v5}.
- Use a soft damp (**with water only**) microfibre cloth when cleaning the Simplicity screen and front acrylic overlay.

Cabinet and door

- The external and internal cup station moulding should be wiped over with warm water and the appropriate cleaning agent/sanitiser.
- Care must be taken to thoroughly clean the cup station area, cup sensor lens, splashguard and drip tray. Use the appropriate cleaning agent/sanitiser for the cup station area only.

Recommended cleaning/maintenance procedures

ALWAYS SWITCH OFF AND DISCONNECT THE MACHINE FROM THE MAINS ELECTRICITY SUPPLY BEFORE CLEANING OR THE REMOVAL OF PARTS.

The quality of drinks produced by the Sigma Simplicity can only be maintained if the machine is cleaned regularly following the required cleaning schedule.

Cleaning agent: always use a suitable vending sanitiser.

Daily cleaning summary

1. Shake and refill all canisters - Page 14.
2. Wipe down the whipper deck.
3. Remove all whipper assemblies and refit a hygiene kit.
4. Empty and clean waste bin (underneath the brewer).
5. Remove and clean all brewer assembly parts i.e. flexi-bowls, brewer chambers, filter carriages and nylon belts, and dry before refitting.
6. Clean the inside cabinet sides and floor.
7. Flush through bowls using the internal flush buttons - Page 17.
8. Clean the overflow bucket.
9. Clean drip tray and grille using sanitiser.
10. Run drink test vends with the door open - using every drink station.
11. Run a payvend or freevend with the door closed.
12. Wipe the cup shelf.
13. With water only - clean the external door, touch sensitive keypad overlay and 12inch screen with a soft damp microfibre cloth.

© Copyright Westomatic Vending Services Limited 2016

All rights reserved. No part of this publication may be reproduced, stored in a retrieval system, or transmitted, in any form or by any means, electrical, mechanical, photocopying, recording or otherwise, without prior permission from Westomatic Vending Services Limited.

Weekly cleaning summary

1. Remove all delivery tubes and dispense head nozzles and clean with a sanitiser.
2. Check all assembly parts - if worn replace with new.
3. Flush through bowls using internal flush switches.
4. Clean drip tray, grille and cup catcher using sanitiser.
5. Empty and clean waste bin and overflow bucket.
6. Clean the inside cabinet sides and floor.
7. Clean the internal door.
8. Clean the external door and 12inch screen with a soft damp microfibre cloth.

Ingredient canisters – removal, filling and cleaning.

1. When removing canisters always position the chutes in the upright position this will prevent any spillages.
2. If your Sigma is fitted with ventilated chutes refit horizontally.

Note! Repetitive turning of the chutes over a period of time can cause the auger fittings to become loose. Turning the chutes manually also makes a mess.

3. Remove the instant ingredient canisters by tilting them backwards to lift the front locating peg from its hole. Pull the canister towards you, whilst lifting the front of the canister by 10mm. The canister(s) can now be removed and placed onto a clean, dry surface.
4. Shake the instant canisters to loosen any compacted ingredient.
5. Place the canisters on a stable surface and fill with dry fresh ingredients to the required level, replacing lid.
6. Do not fill canisters whilst in any machine this will cause the following:
 - Malfunctions
 - Blockages
 - Explosions
 - Dispense pipes will be blocked with beans etc.



DON'T

1. Overfill canisters on low volume machines.
2. Leave bags of product on top of canisters.
3. Leave bags of product or syrup open in the vending machine; this will attract small insects.
4. Overfill the machine with spare ingredient or cups.
5. Leave any debris, product wrappers etc inside the machine.
6. Force components into position.
7. Stand on any lower part of the machine to access the top.

ALWAYS

1. Flush the machine once the canisters and chutes have been refitted.

Whipper assembly & overflow bucket

1. Remove the silicon rubber delivery tubes to the whipper assemblies.
2. Remove all the mixing bowls by releasing the base clip anti-clockwise to the 7 o'clock position (ref: picture on the left).
3. Remove all impellers by pulling them away from the whipper base (ref: picture on the right).
- 4: Remove the whipper bases by rotating the clip further anti-clockwise (to the 6 o'clock position) and pulling forward.
5. Refit a hygiene kit.
6. Place all removed items into a bucket of warm water and an appropriate cleaning agent/sanitiser. Clean thoroughly, rinse and dry for your next machine.
7. Make sure you fit the parts/pipes in exactly the same order, failing to do so will result in the machine malfunctioning.
8. Refit the impellor with **the dot marrying up with the flat part of the whipper shaft**. Failing to do so will result in a **circuit fault** 14-20 or 14-21 or 14-22 or 14-23 or 14-24 or 14-25 or 14-34.



If any parts are scratched, worn, cracked or badly stained, replace immediately. Any of these can cause the machine to malfunction which leads to an Engineer callout.

Overflow bucket and door drip tray.

1. Remove, empty and thoroughly clean the brewer overflow bucket and drip tray.
2. Before refitting the overflow bucket, clean the interior of the cabinet thoroughly with hot water and an appropriate cleaning agent/sanitiser.
3. Make sure the brass pressure weight along with all pipes are **situated inside the overflow bucket before leaving the vending machine**.



How to dismantle the bean to cup / fresh brew coffee brewer for cleaning

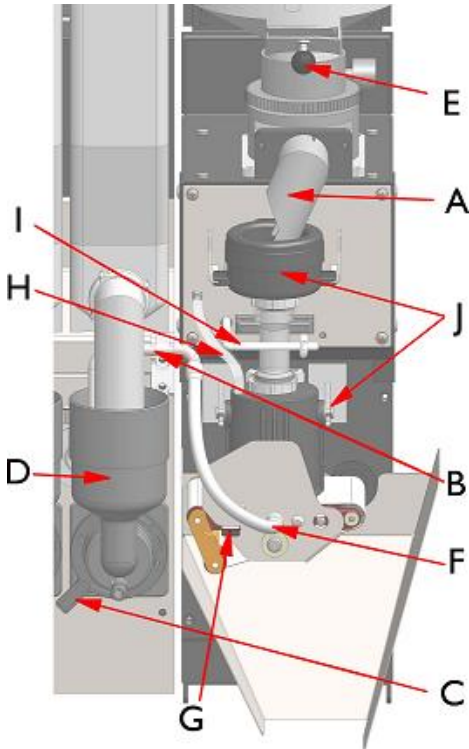

- Switch off the electrical power supply to the machine.
- Remove the ingredient dispense chute (A) from the outlet of the whole bean / FB canister(s) by turning the chute horizontally and then pulling towards you.
- Clean off any dry ingredient residue from the canister outlets with a **dry** scraper.
- Remove the dispense pipe (B) by pulling towards you. Remove the one piece whipper bowl (D) by turning the release arm (C) anticlockwise.
- Place all removed items into a bucket of warm water and an appropriate cleaning agent / sanitiser. Clean thoroughly, rinse and dry.
- If any parts are scratched, cracked or badly stained, replace immediately.
- Re-fit all removed items in the reverse order to removal.
- You must remove all canisters/hoppers when filling.

- Close the shut off flap (E) and then remove the whole bean or FB canister by lifting it upwards and towards you, ensuring a hand is placed on top of the canister lid to prevent any beans or FB ingredient from spilling.
- Upon replacement of the whole bean canister, ensure the shut off flap (E) is returned to the open position.
- Switch on the machine and test for correct operation via the flush buttons and followed by a series of test vends for that particular brewer.

Clean the nylon filter belts and brewer parts every 1250 vends

1. Remove the silicon dispense pipe from the brewer carriage (F) page 16.
2. Unlock the brewer carriage by sliding the lever left (G - behind pipe) page 16, and pull the whole assembly forward to remove.
3. Remove the air pipe (H) page 16.
4. Tilt the air pinch arm to the 12 o'clock left-hand position (I) page 16.
5. Remove with great care the brewer cylinder, followed by the flexi-bowl (J) page 16.
6. Clean thoroughly with appropriate cleaning agent/sanitiser, rinse and dry.
7. Remove the nylon filter belt from the brewer carriage by pressing in the belt lever spring (G) and using the locking plate to hold the lever in place. Remove the nylon belt and clean thoroughly, rinse and dry.
8. Re-fit all removed items.
9. NOTE: When refitting the brewer carriage, ensure the locking plate is correctly positioned to ensure the carriage is securely located.
10. Flush machine and check for leaks.

Every 7000 vends you must replace the nylon filter belt, orange gasket and brewer pot o-ring here's how:-

This does not apply to an all instant machine.

1. Remove, clean and refit all brewer parts as described above and on page 16.
2. Before refitting the black brewer pot replace the o-ring on the bottom.
3. Remove the brewer carriage as described above.
4. Remove the nylon filter belt from the brewer carriage by pressing in the belt retainer spring and using the locking plate to hold the lever (G - behind pipe - page 16) in place. Discard the old belt and also the orange gasket underneath the belt. Now fit a new orange gasket along with a new nylon belt ensuring that the belt is fitted **underneath** the scraper.
5. Now reset the nylon filter count by pressing enter twice on either the "BREWER1 BELT CHANGED" or the "BREWER2 BELT CHANGED" menu in the door open mode, dependent on the machine model.

How to use the flush buttons

1. With the door open, switch on the machine.
2. Ensure waste bucket is positioned under the dispense nozzles.
3. Flush the machine by pressing the appropriate internal flush button situated on the processor cover next to the cup carousel.



Dispense head pipe positions & dispense pipe lengths

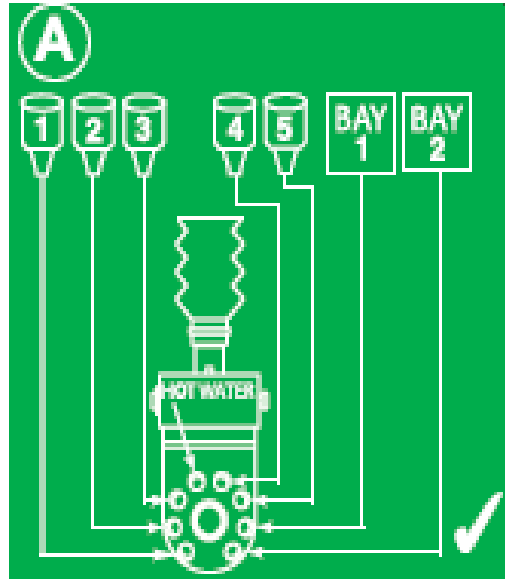
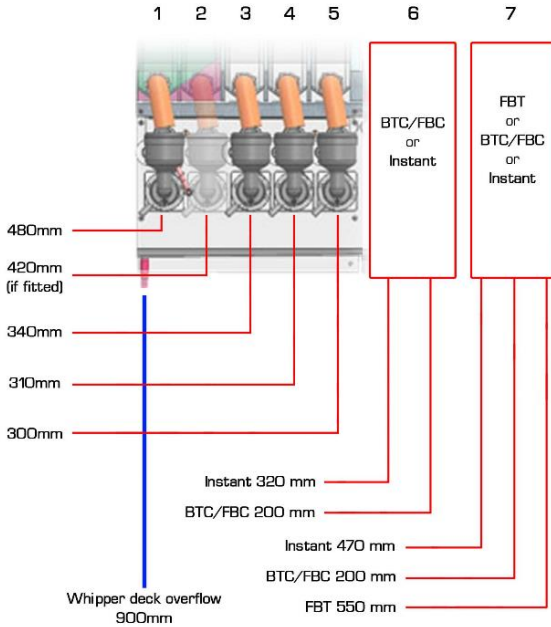

1. Remove all dispense head parts, strap, nozzles, retaining pin and remove the dispense head manifold from the dispense arm by pulling towards you.
2. Place all removed items into a bucket of warm water and an appropriate cleaning agent / sanitiser. Clean thoroughly, rinse and dry.
3. Re-fit the dispense head manifold and secure with the retaining pin.
4. Re-fit the dispense nozzles to the silicon rubber delivery tubes and then insert the nozzles fully into the dispense head manifold.
5. Re-fit the dispense head strap over the dispense pipes.
6. Switch on the machine flush and test for correct operation.
7. You can also test the moving dispense head in the operator functions menu.

Sanitising the syrup lines

For models with either hot or cold configuration.

ROUTINE MUST BE PERFORMED ONCE A MONTH AS A MINIMUM REQUIREMENT.

1. Fill a sanitising bucket with warm water and the right amount of milton sterilising fluid (approx 55cc per 4.5 litres of water). Place the syrup dip tube ends into the bucket of solution and flush the fluid through until the syrup lines are primed full of sterilising fluid. Leave for 15 minutes (how to flush page 17).
2. After 15 minutes, empty the bucket and replace with clean water. Flush through until all traces of sterilising fluid have been removed and the water coming out of the dispense nozzle is pure and clean (this may require several flushes).
3. Remove the dispense nozzle and clean the spout thoroughly with the sterilising fluid. If required the individual dispense spouts can be removed for better access, rinse thoroughly in clean water and place back in nozzle.
4. Re-prime the syrup lines using the internal flush buttons.
6. Test vend all drinks checking for correct operation and drink strengths in drink testing and vend mode.



Final checks!

1. Remove all wrappers and waste materials from the machine.
2. Check there are no leaks from the syrups.
3. Enter drink testing make sure each drink corresponds with the correct mixing bowl. i.e. there should be no deposits of residue (ingredient) left inside any of the mixing bowls.
4. Flush machine.
5. Ensure the door is locked tight.
6. Test the machine for correct operation. Insert coins (if pay vend) and check that the correct credit is displayed.

Operator level door open software menu and their meanings

To access the door open Operator menus simply open the machine door.



The menus on the LCD screen allow you to access files such as the audit. Simply press enter (Page 9) twice and the information will be displayed on the screen.

DISPLAY AUDIT

Audit mode provides the ability to view the overall total drink volume and values dispensed.

READ AUDIT FROM M/C via USB

Your line manager/supervisor will need to provide you with the following tool:

1 x USB flash drive (2GB minimum requirement).

The USB flash drive must be preloaded with a Sigma folder and sub-folders listed below prior to downloading audit information from the Sigma Simplicity machine.



Retrieve the audit via USB

USB Memory stick folder layout and text format

In order to upload software, up/download audit and machine configuration files from the machine, it is necessary to create a 'main' machine folder in the root directory of the machine USB memory stick that contains four sub-folders called 'AUDIT', 'CONFIG', 'FIRMWARE' and 'LANGUAGE' as shown here.

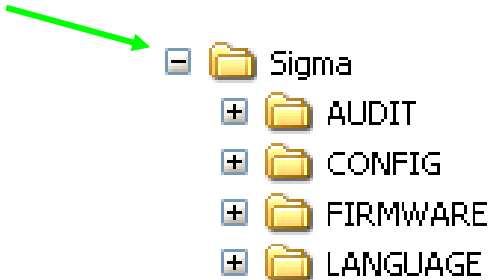

AUDIT - This is where all the uploaded machine audit information is stored

CONFIG - This is where the machine set-up is stored for machine cloning.

FIRMWARE - This is where new software is stored ready for uploading.

LANGUAGE - This is where English & foreign languages are stored for uploading.

The above folders can be created on the USB memory stick using any PC that has a USB port and the 'Windows Explorer' utility.

The port for the USB is located near the internal flush buttons.

Procedure on how to read audit data using the USB flash drive:

Service USB

1. Open the machine door.
2. Insert the USB flash drive into the USB port.



Retrieve the audit via USB

1. Once inserted you will be able to download the audit by pressing enter on: READ AUDIT FROM MACHINE.
2. Once the progression bar has finished your audit has been downloaded onto your USB flash drive.
3. Remove your USB flash drive from the USB port. This can be done while the machine is on.

The other menus are all self explanatory:-

DRINK TESTING

Drink testing enables the Operator to test any drink selections currently active on the machine with the door open. In this mode the drink vend can be monitored visually with the door open to eliminate any minor dispense problems etc.

VERSION INFORMATION

This menu gives Engineers access to the latest firmware.

OPERATOR FUNCTIONS

In Operator Functions the asset number (if assigned) and serial number are stored. Usually in multi unit sites a vendor is given an asset number to aid in machine identification and audit data retrieval/accuracy. Also you will be able to test the moving dispense head and cup test in this mode.

VEND MODE

Pressing enter on VEND MODE will simulate the door being closed. This feature will allow the operator to test that the coin mech is operational for the end user.

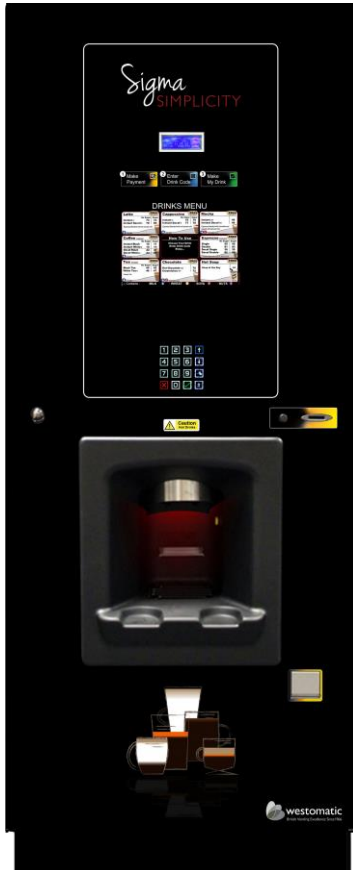

Installation Manual

© Copyright Westomatic Vending Services Limited 2016

All rights reserved. No part of this publication may be reproduced, stored in a retrieval system, or transmitted, in any form or by any means, electrical, mechanical, photocopying, recording or otherwise, without prior permission from Westomatic Vending Services Limited.

Installation contents

25	Electrical information
25	Fuse ratings
25	Water services
25	Noise levels
25	Operating conditions
26	Important pre-installation
26	Levelling
27	Installation checklist
28	Installation checklist
29	Installation & commissioning
30	Connecting mains power & how to enter service mode
31	If fitted – commissioning chiller / carbonator
31	If applicable – how to set up the syrup shots for flavoured coffees
32	Adjusting drink parameters
33	Bean to cup – run a dry throw
34	Bean to cup – the grind
35	How to adjust the gram throws - all fresh ground drinks
36	Cup sensor
37	Setting up the coin mechanism & token acceptance
38	Triac / circuit table
39	Error codes
40	Error codes
41	Useful part numbers
42	Machine maintenance

Electrical information

Supply voltage	220 - 240 Vac
Current	13A Fused RCD protected switched spur
Power	2.4 Kilowatts
Frequency	50Hz
Internal motor voltage	24Vdc
Bean to cup grinder	220 – 240 Vac

A Fused (13 Amp) spur must be protected by a 30mA RCD and wired in accordance with BS7671.

Machine fuse ratings:

F1 Boiler	10A MCB ^{v5}	F8 LED lights	T3.15 Amp
F2 Fan	T0.5 Amp	F9 Cup dropper	T2.0 Amp
F3 Refrigeration	T3.15 Amp	F10 MDH/ inlet valves	T2.0 Amp
F4 PSU AC supply	T3.15 Amp	F11 Whipper motors	T3.15 Amp
F5 220 - 240V supply BTC	T3.15 Amp	F12 Boiler valves	T3.15 Amp
F6 Aux (Not Used)		F13 Ing motors	T3.15 Amp
F7 CPU dc supply	T3.15 Amp	F14 Refrigeration dc	T2.0 Amp

New Sigma Range of machines have a 10Amp MCB (Mains Circuit Breaker) fitted to the boiler supply. ^{v5}

F15 Bay 1
T3.15amp

F16 Bay 2
T3.15amp

Do not fit a different type of fuse rating other than the fuses specified above!

Key: F – Fast Blow fuse : T – Timed Delay Fuse

Water services

Mains water supply from a 15 mm (1/2") rising main.	
Minimum water pressure	0.2Mpa (29 psi / 2 Bar)
Maximum water pressure	0.6Mpa (87 psi / 6 Bar)

Reference should be made to the model water bylaws 1986 statutory instrument (SI) No.1147

Noise levels

The Sigma Simplicity has been designed to work within a user-friendly environment and will therefore not exceed a noise level of 70dB.

Operating conditions

The Sigma Simplicity machine is suitable for indoor use between +10°C and +30°C.

Important pre-Installation Information

The information provided within this handbook has been produced to guide you through correct basic installation and operational requirements. It is strongly recommended to thoroughly read through this handbook prior to attempting installation of the machine.

The Sigma Simplicity has been designed to be able to be quickly and easily installed and provide good quality, well presented drinks from power up. Access to the maintenance area of the machine is via the LCD display screen.

Warning

Before commencing any installation procedure, ensure that all machine site preparation has been completed correctly and that lifting equipment of the correct capacity is available.

We recommend that as much preparation is carried out as possible before installing the machine. A good guide for ensuring the site is properly assessed with the involvement of technical personnel, is the AVA site survey which is available to all member companies from the AVA.

Within the AVA survey, particular attention must be paid to the local hazard analysis evaluation. This will aid in assessing potential risks (such as water quality) when sitting a machine in a particular environment.

Location

The machine is suitable for indoor use only, with an ambient temperature not below 10°C and not exceeding 30°C, and not in an area where a water jet could be used. Please note that the machine will increase the ambient temperature in confined air spaces. The machine should be located to allow access to the appropriate electrical and water services with at least 100mm (4") of free space between the rear of the cabinet and the wall to allow adequate ventilation.

Levelling

It is important that the machine is located on a stable, level surface. The machine should be levelled in both planes by adjustment of the four levelling feet. A spirit level should be used and placed on the cabinet roof and cabinet sides. Incorrect levelling can result in coin acceptance problems, door misalignment and inconsistent cup dispense issues.

Every effort is made by Westomatic to ensure that machines are clean and free from contaminants. We strongly recommend however that as part of the commissioning process, the machine is sanitised using a two-stage process thus:

- Stage 1: Biocide (for the removal of biofilm build up).
- Stage 2: Sanitise (neutralisation of bacteria).

Sigma Simplicity installation checklist

1. Flush the mains water stopcock into a bucket for 30 seconds to remove any dirt or flux from the new or old pipes. Page 29
1. **Fit a water block.** Page 29
2. Make sure that there is sufficient water pressure to the machine by using a pressure gauge. Page 29
3. Open the machine door and remove the inlet hose, this needs to be connected from the stopcock to the $\frac{3}{4}$ inch valve situated half way up on the rear of the cabinet make sure it's a tight fit and turn the stopcock on. Page 29
4. Plug the machine into a dedicated 13amp supply and turn on. Page 30
5. Remove the rest of the accessories from inside the machine if needed.
6. Install the water filter.
7. Level machine. Page 26
8. Load one sleeve of cups into the carousel avoiding the dispense position. Page 12
9. If applicable connect and fit the coin mechanism. Page 37
10. **Very important!** If fitted commissioning chiller / carbonator unit. Page 31
11. Turn machine on by using the internal on / off switch. Page 10.
12. How to access service mode. Page 30
13. Next read the notice on the white canisters, and then remove.
14. Flush the boiler, fill and then drain the boiler.
15. Depending on the water pressure the boiler may not fill completely the first time you power up.
16. When the boiler is heating the green light on the fuse & distribution board will be present this is located behind the 1st canister on the internal left/hand side of machine.
17. If this light is not present check the water fittings and is the stopcock turned on correctly.

While the boiler is heating:

18. Load the remaining cups into the carousel.
19. Fit the plinth to the front bottom of the machine.
20. Please make sure you have the relevant information from your granulated milk supplier – correct gram throw & should the paddle wheel be removed?
21. Load the canisters with correct ingredients and then prime ingredients by turning the auger. Page 14
22. Calibrate the cup sensor to your cups this will need to be done by you. Page 36

Sigma Simplicity installation checklist continued

23. If applicable - how to programme the flavoured syrups to your coffee beverages Page 31.
24. If applicable fit a bin liner to the inside of the waste bucket underneath the brewers.

When the machine has reached its temperature

25. If applicable - Calibrate and test the bean to cup brewer Page 33 onwards
26. If applicable – Set up the tea brewer.
27. Taste & test vend each drink and make sure that there is sufficient water in the mixing bowl before and after the ingredient has been dispensed.
28. Dependant on ingredient some drinks may need the water level decreased / increased. Page 32
29. Ensure the correct chutes have been positioned into the correct bowl.
30. Check that the dispense pipes are correctly fitted into the dispense head
Ref: picture on the processor cover or page 18.

Close the machine door

31. Run a payvend on every drink. Does the drink correspond to the code that you have pressed on the multi-choice keypad?
32. Check coin acceptance / drink value / change given - if applicable.
33. Ensure the cup drops correctly into the cup catcher position.
34. Clean the cup station Page 9.
35. Clean the machine internally, buckets, waste bins ensure that it is presentable.
36. Once you are happy call the customer over for training.

Customer training

Operated sites will only need basic training i.e. on how to vend a drink / coin entry / coin reject / cup sensor / what to expect if the cups / ingredient or change runs out and *behaviours of the machine.

DIY Sites will need full operator training i.e. run through the first part of this manual with them, make sure you cover *behaviours of the machine and error codes 11 & 12 also anything else which maybe of an advantage.

***behaviours of the machine** - e.g. if you remove a cup once you have pressed the keypad for a vend you will not get a drink (instant drinks only) and it is also likely to take your credit as well. Or, if you order an espresso expect half a cup of coffee, etc.

Installation & commissioning

The installation of a new machine is a critical time in the relationship that you as a technician and your company have with the client. First impressions count and last for many years. We recommend that you do as much site and machine preparation as possible before installing the machine.

Warning! A Water-Block safety device must be fitted between the mains incoming supply and the inlet to the water hose.



Pressure gauge

Use a pressure gauge to measure the water pressure and make sure you keep within the guidelines which are on page 25.



Connect water supply

Connect the machine to the mains water supply using the new water hose and seals supplied with the machine – do not use an old hose which will have a build up of * Biofilm.

*A Biofilm is an aggregate of micro organisms in which cells adhere to each other on a surface.

Flush the mains water line thoroughly before connecting to the machine. Make sure the water filter has been flushed prior to installing or at the installation.

Turn screw the 15mm fitting of the mains water supply hose (supplied with the machine) to the rising water main via a stopcock. (Fig1). Now connect the 3/4 inch connector to the Sigma Simplicity and turn the stopcock on and check for leaks). For water pressure guidelines see page 25.



Fig. 1

Stopcock must be a potable cold water supply.



Fig. 2

Connecting mains power

Ensure the machines internal On/Off rocker switch is OFF before connecting to the electrical mains supply. Connect the mains power cord at the rear of the machine to an independent RCD Protected switched mains supply and switch ON to initiate power to the machine.



.How to access service mode

1. With the door open press and hold buttons 1 & # for 5 seconds.
2. Now enter service code 1594 and press enter.



or Jug button

► MACHINE SETTINGS

All the menu parameters required to programme the control of the machine are within MACHINE SETTINGS.

► DRINKS

All the menu parameters required to programme individual drink selections/throw timings are within the DRINKS menu.

► FLUSH MACHINE

In service mode the machine can flush each mixing station individually and test the cup dropper unit.

If fitted commissioning chiller / carbonator unit

Very important! You must purge water through the chiller as soon as you turn the machine on, failing to do so will result in the coils freezing which can take over 12 hours to defrost.

1. Switch the machine's internal ON/OFF rocker switch ON.
2. As soon as the machine has been turned on you must prime the still water using the water flush buttons located on the back of the processor cover. Page 17
3. Continue to prime the water until all air has been expelled from the system and a constant, steady water flow is achieved from the dispense head.
4. If fitted with syrup pumps place the correct dip tube into the correct syrup container. If you are unsure which one is correct place the dip tube in water first and run a pay vend with the door open for that particular syrup. This will help with assigning the correct drink code to your syrup.
5. Prime the syrups through the nozzles in 'flush' mode. Note: After commissioning, it will take the refrigeration system approximately 20 minutes to achieve operating temperature. dependant on ambient conditions.

Prevention of freezing

Insulate any water points to the machine which might be susceptible to freezing. **If any water points freeze** wait until the water has defrosted before using this vending machine.

If applicable – how to programme the syrup shots for flavoured coffees.

1. Open the door.
2. Enter service mode 1594.
3. Enter DRINKS.
4. Scroll up or down an enter SYRUPS.
5. Scroll to SYRUP SHOT 1 and press enter.
6. Enter DRINK SET UP within SYRUP SHOT 1.
7. Enable SYRUP SHOT 1 by press enter then scroll to display a tick followed by pressing enter (Make sure the tick is now locked in i.e. not flashing).
8. Press the back out button once.
9. Now enter DRINK THROWS.
10. Dependant on your cup size alter the correct duration menu.

**For external keypad
button descriptions
refer to pages 9 & 30**

For example if your cup size is 12oz, position the curser on the 12oz duration menu and enter 2 or 3 seconds (Syrups will vary in strength).

11. Add a delay of 10 seconds.
12. Purge the syrup through the lines by pressing the jug button whilst the curser is on the 12oz duration menu.
13. Dependant on your machine type select the required Coffees/Chocolates that you wish to assign the syrups to.

For example if your machine is a BTC model enter FG COFFEES within the DRINKS menu.

14. Now enter the drink which you require the syrup to be assigned to – Latte for example
15. Now enter DRINK SET UP and then press enter again.
16. Scroll down until you reach – ALLOW SYRUP SHOT 1 and press enter.
17. Use the curser buttons to enable the ALLOW SYRUP SHOT 1 and then press enter.
18. A tick will now be present on the right of the display next to ALLOW SYRUP SHOT 1.
19. Now press the back out button until you see SAVING SETTINGS.
20. Now test your drink with the flavoured syrup option in vend mode.
21. Repeat the above process with additional drinks and additional syrups if needed.

© Copyright Westomatic Vending Services Limited 2016

All rights reserved. No part of this publication may be reproduced, stored in a retrieval system, or transmitted, in any form or by any means, electrical, mechanical, photocopying, recording or otherwise, without prior permission from Westomatic Vending Services Limited.

Adjusting drink parameters

You can alter any of the drinks parameters within service mode, this can be done by simply opening the machine door followed by this procedure.

To access menus and adjust parameters you will need to use the external keypad page 9 & 30.

In this example we will use FG CAPPUCCINO.

FG CAPPUCCINO
DRINK SET UP
DRINK THROWS

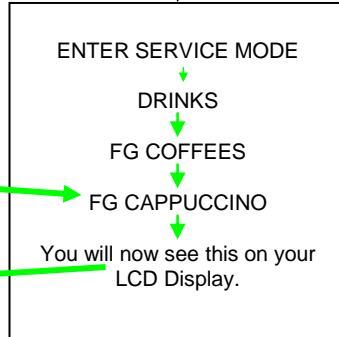

DRINK SET UP

Will allow you to enable or disable a drink. This is very useful for disabling sections of the machine for example:-

If you have a problem with a chocolate whipper motor you can disable all of the chocolate drinks i.e. mocha / chocolate & creamichoc. This will allow you to keep the machine up and running until you can source a new whipper motor.

DRINK THROWS

This menu will allow you to adjust the drinks parameters i.e. drink strength / water levels / whipper timings / pulses and delays.

Very important: Make sure that there is sufficient water in the mixing bowl before and after the ingredient has dispensed. Failing to do so will result in a return visit to the machine to fix one or maybe all three of the following issues – a blockage, flood, or circuit failure.

Bean to cup – Run a dry throw

Very important

Upon receipt of your Sigma Simplicity you will need to calibrate the machine to suit your coffee beans. If you cannot carry out this procedure yourself, your machine is going to fail very quickly!

This is a two part process and must be done in the following order. We recommend using a **DARK ROAST** coffee bean and not light / medium or medium dark roast.

Firstly: The grind

Secondly: Coffee bean gram throw

Follow these procedures to run a dry throw.

- Open the door.
 - Enter security code for service mode access 1594.
 - Scroll to DRINKS then press enter.
 - Scroll to FG COFFEES then press enter.
 - Enter FG ESPRESSO.
 - Scroll to DRINK THROWS then press enter.
 - Enter CAFF INGREDIENT.
 - It will now state the 7 oz, 9 oz or 12 oz DURATION, 5.0 or 10.0 seconds (this is the factory default settings).
 - Press the # or JUG button on the correct duration menu. This will give you a dry gram throw of the bean grind.
- More often than not the grind will be too coarse.
 - Adjust the grind via the dial on the right hand side of the grinder blades - refer to the grind adjustment Page 34.
 - Once you are happy with the grind you will now need to weigh the coffee bean gram throw.



You may also like to make a note below of the coffee which was set up upon installation by you.

Date: _____

Coffee brand: _____ Roast type: _____ Duration of throw: _____ Gram throw: _____

Westomatic loose tea brewer

The Sigma Simplicity tea brewer will not need the same calibration as a bean to cup brewer. Use the same guidelines as on page 32 if needed.

by any means, electrical, mechanical, photocopying, recording or otherwise, without prior permission from Westomatic Vending Services Limited.

The grind

If the grind is too coarse (it will feel like loose tea leaves)

If the grind is too coarse the water rushes through the coffee too quickly.

This results in a weak espresso with very little crema and sludgy coffee grout waste. (Under extracted) ultimately this will cause the brewer chamber to block and explode.

What to do!

Adjust the grinder blades so that you are turning the dial clockwise. This will close the blades so that they are closer together resulting in a finer grind.

Warning!

Each time you adjust the grinder blades remember to vend **three dry throws**, this will clear the previous grinds, and then run a dry test throw on the fourth to feel the grind.

If the grind is too fine (it will feel like talcum powder)

If the grind is too fine the water passes through the coffee too slowly. This results in a dark bitter taste which will be over extracted and cause the brewer chamber to flood or eventually to explode.

What to do!

Adjust the grinder blades so that you are turning the dial anti-clockwise. This will open the blades so that they are not too close resulting in a coarser grind.

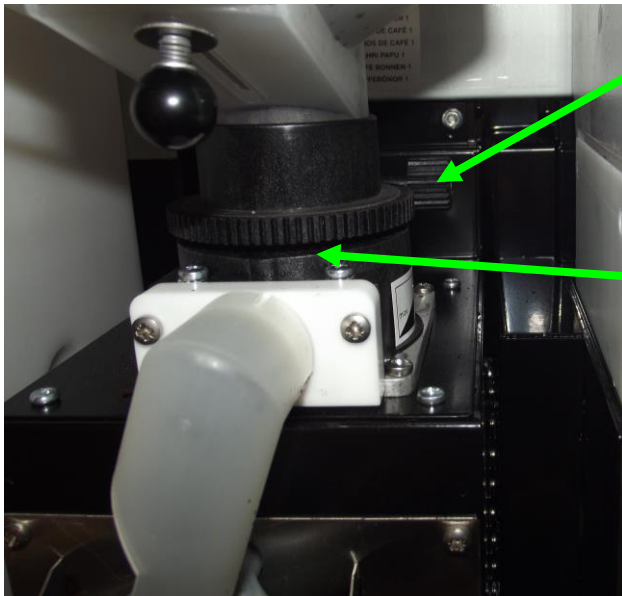

Grind adjustment dial.

As a starting point place a pound coin in this gap and turn the grind adjustment dial until the coin is a tight fit.

How to adjust the gram throws on all fresh ground drinks

- Enter the DRINKS menu.
- Enter CHANGE ALL.
- Scroll up and enter - ALL FG INGREDIENT.
- Make sure the menu is - ALL FG INGREDIENT - instead of -ALL FB INGREDIENT.
- By using the scroll buttons press enter on the required menu i.e. INCREASE BY or DECREASE BY.
- This menu will now be flashing.
- Enter the desired percentage by using the multi-choice touch sensitive keypad.
- Once you have pressed enter the percentage menu will stop flashing.
- Press the back out button.
- After you have completed this you will need to re-enter the FG ESPRESSO.
- Now vend a dry throw (refer to page 33) and weigh the coffee using your mini-scales.
- Keep using the above process until you reach your goal of 7-8 grams per cycle.

**For external keypad
button descriptions
refer to pages 9 & 30**



Once the above procedure has been completed, test vend 10 fresh ground espresso drinks with the door open to ensure that there are no failures. A key requirement is a consistent coffee cake which should look not too wet and not too dry, aim for a perfectly extracted coffee cake.

With 12 oz default settings the brewer will cycle twice on the following drinks: Cappuccino, Latte, Skinny Latte, Flat White, Americano and Double Espresso/Macchiato, therefore the duration value will be double that of a single espresso or macchiato.

For example:

If the espresso gram throw equates to 4 seconds = 7 grams, the latte will be double the value - 8 seconds = 14 grams (remember the brewer will complete two cycles on a 12 oz cup as a default which will work out at 7 grams per cycle once calibrated).

Cup sensor

Tools needed:

Small flat headed screw driver – watch type

Please note that your Sigma Simplicity hot beverage machine has been through a full test procedure at Westomatic Vending Services Ltd. However the cup which we used to test the cup sensor on your machine may differ to the cup which you are about to load into the cup turret tubes.

Cups will vary as you know from plastic to paper and from white to black. Therefore it is imperative that you test your cup sensor upon installation and adjust the setting on the sensor if needed. You may also like to make a note below of the cup which was set up upon installation by you.

Date_____ Cup brand_____ Cup size_____ Cup Colour_____

How the cup sensor operates

1. Firstly look at the sensor whilst there is no cup present in the cup catcher.
2. If the green light is on then this is correct. The green light means power on.
3. Test vend a cup into the cup catcher in Operator functions with the door open.
4. Both green and orange lights will now be present on the sensor when there is a cup in the cup catcher.
5. If you remove the cup and the green light is the only light left on, you are now safe to test the machine with the door closed.

If none of the above applies follow the instructions below:-

Programming the cup sensor

1. Adjust the sensor so that both lights are present.
2. Then adjust the sensor so that the orange light fractionally turns off which leaves the green light still present on the sensor.
3. Then a test is carried out using the test the cup within the OPERATOR FUNCTIONS while the door is open.
4. Once the cup unit drops a cup into the cup catcher both lights are present.
5. This means that the cup sensor is successfully transmitting and receiving a sensor beam to and from the cup.
6. If the cup drops and only the green light is present, we will fine tweak the sensor pot so that the orange light is on and start the test procedure again.
7. Once the sensor has been correctly set up we will then close the door and run a series of test vends which will also include removing the cup so that the processor responds by aborting the drink. If BTC or SFB models the brewer will complete the cycle before aborting.

Coin mechanism information

Tools needed:
Crosshead screwdriver

Your Sigma Simplicity machine has been through a full test procedure at Westomatic. This also includes testing for a payment system even if your machine is a freevend only specification.

Very important:

Your coin mechanism must be firmly mounted using the three screws on the internal metal work bracket below the coin return.

Isolate your machine when connecting the MDB coin mechanism loom to the MDB plug on the machine. Failing to do so will cause the circuit to malfunction.

Floating the coin mechanism

With the machine on you must float the coin-mech with:

1. The corresponding change which suits the coin mechanism.
2. Use the coin mechanism manufacturer's recommendations when floating the mech. This is always done through the coin mechanism's programming.

To change drink prices

1. Enter MACHINE SETTINGS
2. Enter PRICE SETTINGS
3. Adjust the price of the drink/s

If your Sigma Simplicity has been ordered as a payment set up, the programming will already be set up for you i.e. the machine will be programmed to pay vend.

If however you need to change the settings at a later date this can be carried out in:

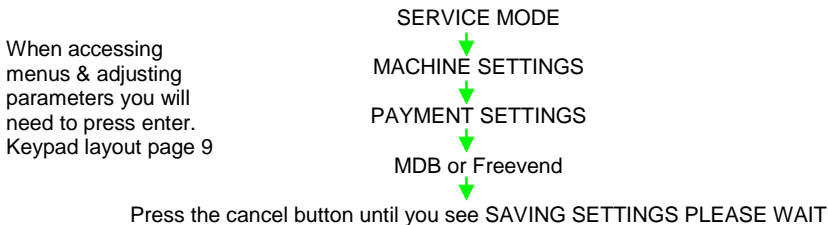

Coin Set – This menu sets the LCD display message to show the relevant coinage

0 = 1,2,5,10,20,50p & £1

1 = 1,2,5,10,20,50p, £1 & £2

2 = 5,10,20,50p & £1

9 = 5,10,20,50p, £1 & £2

For token acceptance

Set the Coin Type to 3 within the correct coin acceptance channel.

Try coin acceptance 7 or 9 first.

All rights reserved. No part of this publication may be reproduced, stored in a retrieval system, or transmitted, in any form or by any means, electrical, mechanical, photocopying, recording or otherwise, without prior permission from Westomatic Vending Services Limited.

Sigma Simplicity circuit table

In the event of a circuit fault the 14 represents an open circuit, the number after the hyphen represents the circuit with the fault. The table below allows you to pinpoint the fault, for example: 14-20 would be an open circuit regarding the whipper station 1.

Circuit number	Function	Connector
1	Master water inlet	P10
2	Hot water inlet	P9
3	Cold water inlet	P8
4	Brewer 1 Air Pincher	P7
5	Brewer 2 Air Pincher	P6
6	Water Station 1	P5
7	Water Station 2	P4
8	Water Station 3	P3
9	Water Station 4	P2
10	Water Station 5	P1
11	Water Station 6 (Bay 1)	O12
12	Water Station 7 (Bay 2)	O11
13	Ingredient motor 1	O10
14	Ingredient motor 2	O9
15	Ingredient motor 3	O8
16	Ingredient motor 4	O7
17	Ingredient motor 5	O6
18	Ingredient motor 6	O5
19	Ingredient motor 7	O4
20	Whipper 1	O3
21	Whipper 2	O2
22	Whipper 3	O1
23	Whipper 4	N10
24	Whipper 5	N9
25	Whipper 6	N8
26	Cup Peeler motor	N7
27	Cup transfer motor	N6
28	MDH Motor	N5
29	Station / Bay 2 Pinch solenoid	N4
30	Station / Bay 1 Pinch solenoid	N3
31	Brewer 1 Air Pump	N2
32	Brewer 2 Air Pump	N1
33	Water Station 8	R8
34	Whipper 7	R7
35	UV Lamp	R6
36	Syrup 1	R5
37	Syrup 2	R4
38	Syrup 3	R3
39	Still Water	R2
40	Carbonated Water	R1
41	Ingredient motor 8	Q8
42	Internal light	Q7
43	Spare	Q6
44	Spare	Q5
45	Spare	Q4
46	Spare	Q3
47	Spare	Q2
48	Spare	Q1

Sigma Simplicity Error Codes

when swapping motors/components turn the machine off!

Error code 9

Fault Description – Keyboard Fault or Button stuck.

Actions to take:

- Disconnect external keypad and power up the machine, if fault disappears then check the key pad/loom, replace keypad.
- If fault persists then replace the Processor board.

Error code 11

Fault Description - Cups sold out or switch damaged.

Actions to take:

- Ensure there are cups present within the motorised cup unit.
- Ensure the cup switch in the cup unit works correctly.

Error code 12

Fault Description - Waste overflow bucket is full.

Actions to take:

- Empty and replace the overflow bucket make sure the brass pressure weight is on the inside of the overflow bucket.
- To reset the machine - power down for 10 seconds and then turn back on using the rocker switch. page 10
- Test the pressure switch and replace if necessary.

Error code 13

Fault Description – Boiler probe set has not detected water.

Actions to take:

- Check the water has not been turned off at the stop cock. Page 29
- Check water supply to inlet valves is no less than 2bar.
- Are there appliances near by draining the water pressure?
- Ensure the probe set terminals are a tight fit on top of the boiler lid.
- Check continuity from the probe set to the processor on all terminals and plugs.
- Check for scale obstructing the fill level probe inside the boiler. De-scale if necessary.
- Replace the probe set.

Error code 14

Fault Description – Triac/circuit failure.

Actions to take:

- Check the output table within diagnostics for the circuit at fault. See page 38 for circuit numbers.
- Check the fuse associated to the circuit. For example F11 fuse protects whipper circuits 20 to 24.
- Check all crimps and connectors to the motor/component.
- Replace the motor/component with new. Has the fault gone? Or swap the motor/component over with its neighbour has the circuit number changed (refer to page 38). If yes, replace with a new motor/component.

For service engineers who do not have immediate access to parts.

- If you do not hold spare parts, disable the drinks associated with that particular motor/component. This will keep the machine up and running until you schedule a return visit to replace the motor/component.
- If the fault is still present re-check the terminals to the motor/component. Also check the terminal within the output plug on the processor (Do all female terminals within this particular circuit make a good contact with the male terminals?).
- Using a multi-meter check the output circuit and also the red common circuit for breaks.
- Replace the control board.

Error code 20

Fault Description – Water Fail safe.

Actions to take:

- Check the machine for internal water leak.
- Check for scale obstructing the probeset inside the boiler. De-scale if necessary.
- Fault code will be rectified by interrupting power.

Error code 21

Fault Description – Leak Detected / Boiler / Valve leak detection.

Actions to take:

- Check the boiler for leaks.
- Check boiler valves for scale and replace if necessary.
- Check / replace the main water inlet valves.
- Check the Leak detect value in software is correct.
- Check for scale obstructing the fill level probe inside the boiler. De-scale if necessary.
- Check boiler for scale. De-scale if necessary.
- Follow the guidance under Error 13 - both Errors are very similar.

Sigma Simplicity Error Codes

when swapping motors/components turn the machine off!

Error code 30

Fault Description – Dispense Arm Jam timeout activated.

Actions to take:

- The Dispense arm has not moved or activated the switch within the time set (5 seconds),
- Check the condition of the switches and the dispense arm motor.
- Replace if necessary.

Error code 50

Fault Description – Brewer 1 Fault.

Actions to take:

- Check the brewer micro switch is homing correctly.

Error code 52

Fault Description – Brewer 2 Fault

Actions to take:

- Check the brewer micro switch is homing correctly.

Error code 56

Fault Description – Boiler full & empty

Actions to take:

The processor detects signals from the boiler probe set that indicate that the boiler is both empty & full at the same time.

- Ensure the probeset is free from scale.
- Replace boiler probeset.

Error code 57

Fault Description – Boiler Overflow.

Actions to take:

- Ensure machine is level.
- Ensure probes are connected and fitted to the boiler lid.
- Ensure the boiler lid is fitted to the boiler and all gaskets are in place.
- Ensure the probeset is free from scale.

Error code 58

Fault Description – Boiler Under temperature.

Actions to take:

- Ensure the connectors are fitted correctly.
- Check / replace the boiler fuse.
- This fault will also show if there is no water to the machine.

Error code 59

Fault Description – Temperature Thermistor open circuit.

Actions to take:

- Ensure the probe connectors are fitted correctly.
- Ensure the probe is connected to the control board.
- Replace boiler probeset.

Error code 60

Fault Description – Bean grinder timeout.

Actions to take:

- Ensure Grinder is connected.
- Ensure the grinder fuse is fitted.
- Ensure no objects are jammed in grinder.

Error code 61

Fault Description – Drive motor not reaching home within the timeout set.

Actions to take:

- Ensure the brewer is mounted correctly in the machine.
- Ensure the connectors are fitted correctly.
- Replace the drive motor for the brewer

Error code 84

Fault Description – Fault generated by a bill reader.

Actions to take:

- Check the EVA DTS code, this will be displayed within the fault log.
- EVA & DTS codes can be download via the internet:-
www.vending-europe.eu/standards/EVA-DTS.html

Useful part numbers

NYLON FILTER BELT	1039005
BREWER CYLINDER O RING	1026011
BOWL & CHAMBER (BLACK) ^{V5}	1054038
WHIPPER IMPELLOR (BLACK) ^{V5}	1054040
WHIPPER BASE (GREEN) ^{V5}	1054041
LCD DISPLAY	1042002
MIXING BOWL TEA BREWER (GREY) ^{V5}	1054014
STEAM HOOD TEA BREWER (GREY) ^{V5}	1054011
COFFEE BREWER SERVICE KIT ^{V5}	2099506
PHOTO SCREEN	1042021
PHOTO SCREEN BRACKET	1037286
INSTANT HYGIENE KIT ^{V5}	9199624
MULTIBREWER HYGIENE KIT ^{V5}	9199625
MDH STRAP	1026005
CANTILEVER ARM	1037089
COFFEE PINCH SOLENOID 24V	1050003
TEA PINCH SOLENOID 24V	1050002
AIR PUMP 24V 0.5bar ^{V5}	1046001
WHIPPER MOTOR 24V (BLACK) ^{V5}	1040018
INLET VALVE ASSEMBLY24V	1029024
BOILER VALVE 8mm BODY LOW SCALE 24VDC	1053003
DELIVERY VALVE SEAL – CLEAR	1029017
PRESSURE SWITCH	1052002
24V CUP DROP UNIT – 73MM / 7OZ SQUAT OR 9OZ CUP	1016004
24V CUP DROP UNIT – 80MM / 12OZ CUP	1016007
EXTRACTOR FAN MOTOR (NOT ASSEMBLY) ^{V5}	1020001
INGREDIENT MOTOR 90RPM	1040007
INGREDIENT MOTOR 130RPM (Chocolate) ^{V5}	1040008
GRINDER RELAY PCB 230V AC	1042007
GRINDER 230V AC	1055001
PSU 240VAC TO 24VDC	1017002
PROBE SET	1045002
BOILER ELEMENT	1019002
CUP SENSOR	1049001
SIGMA CPU	1042004
SUPER BLUE SCREEN CLEANING CLOTH (Pack 25) ^{V5}	1015006
ESPRESSO BREWER CLEANING TABLETS (Pack 200) ^{V5}	9199607
SILICON DISPENSE HOSE 6MM X 2MM PER METRE ^{V5}	1029011
DISPENSE NOZZLE X1 ^{V5}	1044002

Machine maintenance every 4 - 6 months

Boiler & water services

1. Descale the probe set.
2. Descale the boiler valves.
3. Check the calibration of all boiler valves – 6fl oz / 10 seconds
4. Replace the boiler seals.
5. Descale the element.
6. Replace the water filter.
7. Check water pressure.
Minimum water pressure 2bar
Maximum water pressure 6bar

Bean to cup grinder

1. Remove and clean bean canister.
2. Check the grinder blades and replace every 30,000 vends.
3. Calibrate the BTC brewer - grind & gram throw.

Brewer/s

1. Replace the nylon filter belt/s.
2. Replace the orange gasket and o-ring on both brewers.
3. Clean the filter carriages remove all coffee & tea grouts.

Fuses & boiler interface board

1. Check all fuses are of the correct value.
2. All fuse holders need to be a tight fit – replace if needed.

Extraction area

1. Clean the complete extraction system including removal and cleaning of extraction fan motor assembly and tubing.
2. Clean extraction area & tubing on both brewers.

Cup unit

1. Remove the carousel and clean the cup unit.
2. Test the cup unit for operation i.e. let it self fill & test the cup drop.
3. Check calibration of the cup sensor.

Coin mechanism if applicable

1. Clean the coin mech validator.
2. Clean the coin chute.
3. Coin test mechanism checking change payout of each available coin.

Machine / cabinet

1. Make sure the machine is level.
2. Make sure the door lock opens and closes with ease.

Drink tests

1. Ensure all drinks rinse correctly – check for over dosing.
2. Take pay/free vends with the door closed & check for correct dispense.

© Copyright Westomatic Vending Services Limited 2016

All rights reserved. No part of this publication may be reproduced, stored in a retrieval system, or transmitted, in any form or by any means, electrical, mechanical, photocopying, recording or otherwise, without prior permission from Westomatic Vending Services Limited.

Notes

How to download technical manuals from the Westomatic website:-

- 1. Enter Westomatic into your search engine.**
- 2. Enter the website.**
- 3. Click on: WestoNET Support**
- 4. Click on: Manuals, Software & Part Numbers**
- 5. You will now have complete access to our manuals.**

